

DH-SD6463E/65E/66E-HN

18x/28x/36x D1 WDR Network IR PTZ Dome Camera



Features

- Powerful 18x/28x/36x optical zoom
- H.264 & MJPEG dual-stream encoding and JPEG image capture
- 25/30fps@D1(4CIF)/CIF/VGA resolution
- WDR, Day/Night (ICR), DNR (2D&3D), Auto iris, Auto focus, AWB, AGC, BLC, EIS
- Multiple network monitoring: Web viewer, CMS(DSS/PSS) & DMSS
- Max 240°/s pan speed, 360° continuous pan rotation
- Up to 255 presets, 5 auto scan, 8 tour, 5 pattern
- Built-in 2/1 alarm in/out
- Support intelligent 3D positioning with DH-SD protocol
- Micro SD memory, IP66, IR Distance up to 100m

DH-SD6463E/65E/66E-HN

Technical Specifications:

Model	DH-SD6463E-HN	DH-SD6465E-HN	DH-SD6466E-HN
Camera			
Image Sensor	1/4" EXview HAD CCD		
Effective Pixels	PAL: 752(H) x 582(V), NTSC: 768(H) x 494(V)		
Scanning System	Progressive		
Electronic Shutter Speed	1/3(4) ~ 1/10000 sec (20 steps)		
Min. Illumination	0.7 lux (F1.4, 50IRE)	0.65 lux (F1.35, 50IRE)	1.4 lux (F1.6, 50IRE)
	0.04 lux/Color	0.04 lux/Color	0.1 lux/Color
	0.01 lux/B/W, (1/3,1/4 sec)	0.005 lux/B/W, (1/3,1/4 sec)	0.01 lux/B/W, (1/3,1/4 sec)
S/N Ratio	More than 50dB		
Video Output	BNC(1.0Vp-p/75Ω), PAL / NTSC		
Camera Features			
IR Distance	100m		
Day/Night	Auto(ICR) / Color / B/W		
Backlight Compensation	BLC / HLC / WDR		
White Balance	Auto, ATW, Indoor, Outdoor, Manual		
Gain Control	Auto / Manual		
Noise Reduction	2D / 3D		
Privacy Masking	Up to 24 areas		
Digital Zoom	12x		
Image Stabilization	Electronic Image Stabilizer (EIS)		
Lens			
Focal Length	4.1mm ~ 73.8mm (18x optical zoom)	3.5mm ~ 98.0mm (28x optical zoom)	3.4mm ~ 122.4mm (36x optical zoom)
Max Aperture	F1.4 ~ F3.0	F1.35 ~ F3.7	F1.6 ~ F4.5
Focus Control	Auto / Manual		
Angle of View	H: 48° ~ 2.8°	H: 55.8° ~ 2.1°	H: 57.8° ~ 1.7°
Close Focus Distance	10mm ~ 800mm	10mm ~ 1500mm	10mm ~ 1500mm
PTZ			
Pan/Tilt Range	Pan: 0° ~ 360° endless; Tilt: -15° ~ 90°, auto flip 180°		
Manual Control Speed	Pan: 0.1° ~ 160°/s; Tilt: 0.1° ~ 120°/s		
Preset Speed	Pan: 240°/s; Tilt: 200°/s		
Preset	80(DH-SD) , 255 (Pelco-P/D)		
PTZ Mode	5 Pattern, 8 Tour, Auto Pan, Auto Scan		
Speed Setup	Human-oriented focal length / speed adaptation		
Power up Action	Auto restore to previous PTZ and lens status after power failure		

DH-SD6463E/65E/66E-HN



Idle Motion	Activate Preset/Pan/Scan/Tour/Pattern if there is no command in the specified period	
Protocol	DH-SD, Pelco -P/D (Auto recognition)	
Video		
Compression	H.264 / MJPEG	
Resolution	D1(704×576/704×480) / CIF(352×288/352×240) / QCIF(176×144/176×128) / VGA(640×480) / QVGA(320×240)	
Record Speed	Main Stream	1~25/30fps at all resolution
	Sub Stream	1~25/30fps at all resolution
Bit Rate	56K ~ 4096Kbps	
Audio		
Compression	G.711a / G.711u (32kbps) / PCM (128kbps)	
Interface	1/1 channel In/Out	
Network		
Ethernet	RJ-45 (10/100Base-T)	
Protocol	IPv4/IPv6, HTTP, HTTPS, SSL, TCP/IP, UDP, UPnP, ICMP, IGMP, SNMP, RTSP, RTP, SMTP, NTP, DHCP, DNS, PPPOE, DDNS, FTP, IP Filter, QoS, Bonjour	
ONVIF	ONVIF Ver. 2.0 conformance	
Max. User Access	20 users	
Smart Phone	iPhone, iPad, Android, Windows Phone	
Auxiliary Interface		
Memory Slot	Micro SD, Max 64GB	
RS485	1	
Alarm	2/1 channel In/Out	
General		
Power Supply	AC24V/3A (±10%), DC12V optional	
Power Consumption	13W, 25W(Heater on)	
Working Environment	-40°C ~ 60°C / Less than 90% RH	
Ingress Protection	IP66	
Dimensions	Φ185(mm) x 299(mm)	
Weight	5.0kg	

DH-SD6463E/65E/66E-HN

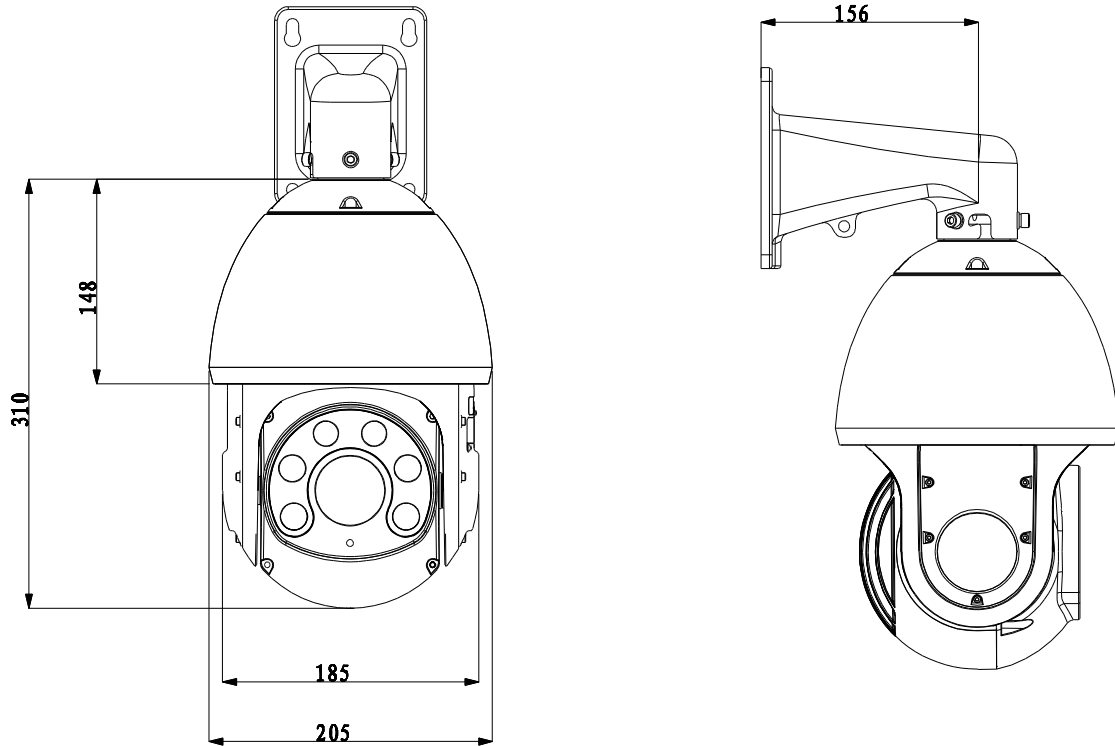
Dimensions (mm)







Accessories

	
DH-64FB	Power Supply

DH-SD6463E/65E/66E-HN

Accessories (Optional)

				
DH-PFA114	DH-PFB300C	DH-PFB301C	DH-PFA112	DH-PFA113
				
DH-PFB301S	DH-PFA120	DH-PFA150	DH-PFA151	

Dahua Technology Co., Ltd.

1187 BinAn Road, Binjiang District, Hangzhou, China

Tel: +86-571-87688883

Fax: +86-571-87688815

Email: overseas@dahuatech.com

www.dahuasecurity.com

*Design and specifications are subject to change without notice.

© 2013 Dahua Technology